

Features:

- Φ34 mm , Plastic housing;
- 25mm , flush mountable;
- DC 3-wire , switching output;
- Cable

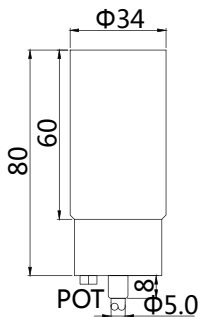

Dimensioned drawing



Model No.

| Sensing range | Sn:2-25 mm |
|---------------|-----------------|
| NPN N. O | CB-H3425N-P11P2 |
| NPN N. C | CB-H3425N-P21P2 |
| PNP N. O | CB-H3425P-P11P2 |
| PNP N. C | CB-H3425P-P21P2 |

Mounting

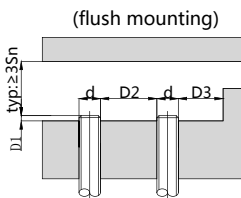

| Correction Factor | |
|-------------------|--------|
| Nav-ferrous metal | Factor |
| Water | 1 |
| Alcohol | 0.7 |
| Ceramic | 0.6 |
| Glass | 0.5 |
| Oil | 0.3 |

Technical data

| | | |
|------------------------------|--------------------------|----------------------------|
| Electrical data | Operating voltage | 10-30V DC |
| | Switching frequency | 100Hz |
| | Voltage drop | ≤2.0V |
| | Leakge current | <0.01mA |
| | Load current | 200mA |
| | No load current | ≤10mA(24V) |
| | Hysteresis | <15%(Sr) |
| | Repeatability | <5.0%(Sr) |
| | Temperature drift | <10%(Sr) |
| | Short circuit protection | Yes |
| | Overload protection | Yes |
| Polarity reversal protection | Yes | |
| Environment | Ambient temperature | -25...70°C |
| | Ingress protection | IP67 |
| Mechanical data | Housing material | PBT |
| | Face material | PBT |
| Electrical connection | Connectors | PVC cable/2m ; 3*0.35mm² |
| Accessories | Accessories | NO |
| | | (to be ordered separately) |

Wiring

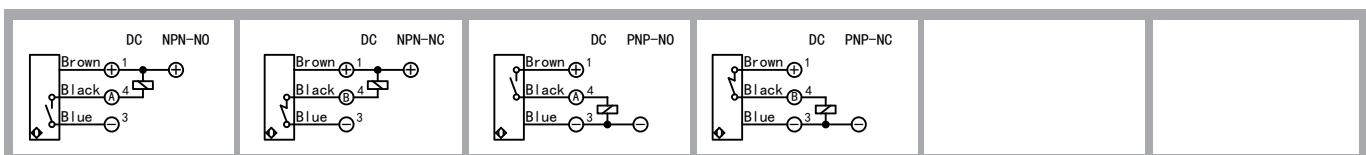



Features:

- Φ34 mm , Plastic housing;
- 35mm , non-flush mountable;
- DC 3-wire , switching output;
- Cable



Dimensioned drawing

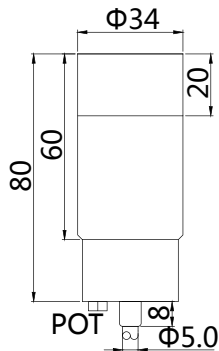

Mounting

(non-flush mounting)

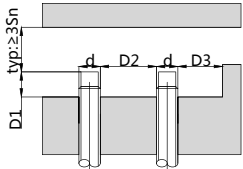

| Correction Factor | |
|-------------------|--------|
| Nav-ferrous metal | Factor |
| Water | 1 |
| Alcohol | 0.7 |
| Ceramic | 0.6 |
| Glass | 0.5 |
| Oil | 0.3 |

Model No.

| Sensing range | Sn:2-35 mm |
|---------------|-----------------|
| NPN N. O | CN-H3435N-P11P2 |
| NPN N. C | CN-H3435N-P21P2 |
| PNP N. O | CN-H3435P-P11P2 |
| PNP N. C | CN-H3435P-P21P2 |

Technical data

| | | |
|------------------------------|--------------------------|----------------------------|
| Electrical data | Operating voltage | 10-30V DC |
| | Switching frequency | 100Hz |
| | Voltage drop | ≤2.0V |
| | Leakge current | <0.01mA |
| | Load current | 200mA |
| | No load current | ≤10mA(24V) |
| | Hysteresis | <15%(Sr) |
| | Repeatability | <5.0%(Sr) |
| | Temperature drift | <10%(Sr) |
| | Short circuit protection | Yes |
| | Overload protection | Yes |
| Polarity reversal protection | Yes | |
| Environment | Ambient temperature | -25...70°C |
| | Ingress protection | IP67 |
| Mechanical data | Housing material | PBT |
| | Face material | PBT |
| Electrical connection | Connectors | PVC cable/2m ; 3*0.35mm² |
| Accessories | Accessories | NO |
| | | (to be ordered separately) |

Wiring

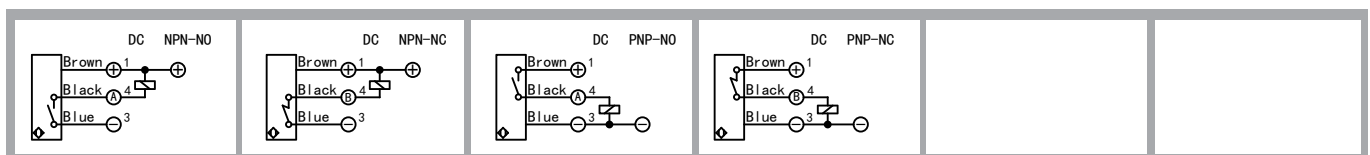



Features:

- Φ34 mm , Plastic housing;
- 25mm , flush mountable;
- DC 3-wire , switching output;
- Cable & pigtail versions



Dimensioned drawing

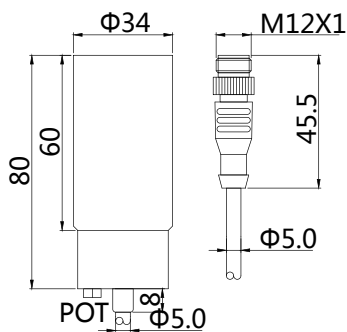

Model No.

| Sensing range | Sn: 2-25 mm |
|---------------|------------------|
| NPN N. O | CB-H3425N-P11Z12 |
| NPN N. C | CB-H3425N-P21Z12 |
| PNP N. O | CB-H3425P-P11Z12 |
| PNP N. C | CB-H3425P-P21Z12 |

Mounting

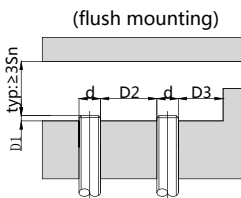

| Correction Factor | |
|-------------------|--------|
| Nav-ferrous metal | Factor |
| Water | 1 |
| Alcohol | 0.7 |
| Ceramic | 0.6 |
| Glass | 0.5 |
| Oil | 0.3 |

Technical data

| | | |
|------------------------------|--------------------------|----------------------------|
| Electrical data | Operating voltage | 10-30V DC |
| | Switching frequency | 100Hz |
| | Voltage drop | ≤2.0V |
| | Leakge current | <0.01mA |
| | Load current | 200mA |
| | No load current | ≤10mA(24V) |
| | Hysteresis | <15%(Sr) |
| | Repeatability | <5.0%(Sr) |
| | Temperature drift | <10%(Sr) |
| | Short circuit protection | Yes |
| Overload protection | Yes | |
| Polarity reversal protection | Yes | |
| Environment | Ambient temperature | -25...70°C |
| | Ingress protection | IP67 |
| Mechanical data | Housing material | PBT |
| | Face material | PBT |
| Electrical connection | Connectors | M12 connectotr |
| Accessories | Accessories | B12-4GV2/B12-4WV2 |
| | | (to be ordered separately) |

Wiring

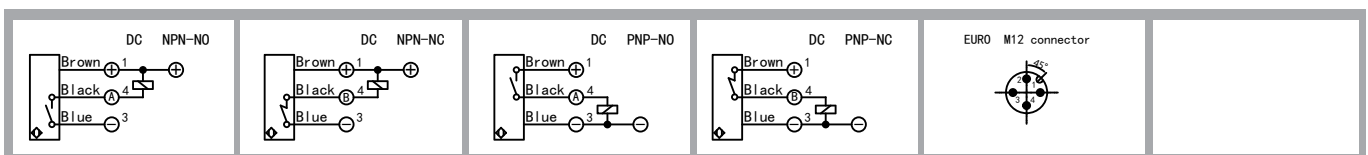



Features:

- Φ34 mm , Plastic housing;
- 35mm , non-flush mountable;
- DC 3-wire , switching output;
- Cable & pigtail versions



Dimensioned drawing

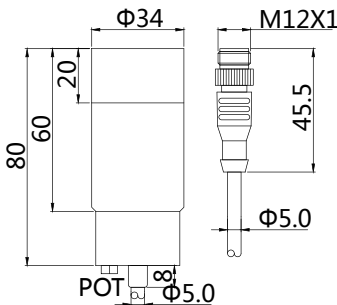

Mounting

(non-flush mounting)

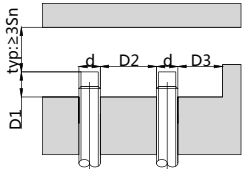

| Correction Factor | |
|-------------------|--------|
| Nav-ferrous metal | Factor |
| Water | 1 |
| Alcohol | 0.7 |
| Ceramic | 0.6 |
| Glass | 0.5 |
| Oil | 0.3 |

Model No.

| Sensing range | Sn:2-35 mm |
|---------------|------------------|
| NPN N. O | CN-H3435N-P11Z12 |
| NPN N. C | CN-H3435N-P21Z12 |
| PNP N. O | CN-H3435P-P11Z12 |
| PNP N. C | CN-H3435P-P21Z12 |

Technical data

| | | |
|------------------------------|--------------------------|----------------------------|
| Electrical data | Operating voltage | 10-30V DC |
| | Switching frequency | 100Hz |
| | Voltage drop | ≤2.0V |
| | Leakge current | <0.01mA |
| | Load current | 200mA |
| | No load current | ≤10mA(24V) |
| | Hysteresis | <15%(Sr) |
| | Repeatability | <5.0%(Sr) |
| | Temperature drift | <10%(Sr) |
| | Short circuit protection | Yes |
| Overload protection | Yes | |
| Polarity reversal protection | Yes | |
| Environment | Ambient temperature | -25...70°C |
| | Ingress protection | IP67 |
| Mechanical data | Housing material | PBT |
| | Face material | PBT |
| Electrical connection | Connectors | M12 connector |
| Accessories | Accessories | B12-4GV2/B12-4WV2 |
| | | (to be ordered separately) |

Wiring

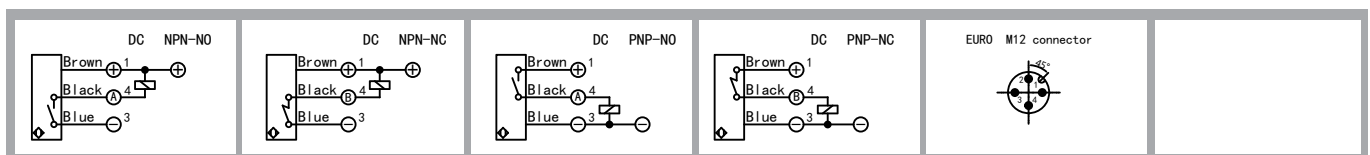



Features :

- Φ34mm Plastic housing;
- 25mm , flush mountable;
- AC 2-wire , AC/DC 2-wire , switching output;
- Momentary current:5A(20ms)/2.2A(20ms)
- Cable



Dimensioned drawing

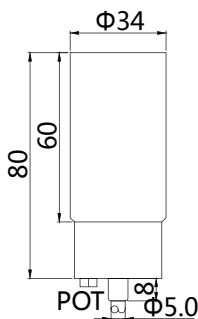

Model No.

| Sensing range | Sn:2-25 mm |
|---------------|-----------------|
| N. O | CN-H3425A-P14P2 |
| N. C | CN-H3425A-P24P2 |
| N. O | CN-H3425U-P15P2 |
| N. C | CN-H3425U-P25P2 |

Mounting

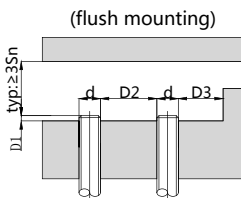

| Correction Factor | |
|-------------------|--------|
| Nav-ferrous metal | Factor |
| Water | 1 |
| Alcohol | 0.7 |
| Ceramic | 0.6 |
| Glass | 0.5 |
| Oil | 0.3 |

Technical data

| | | |
|------------------------------|------------------------------|-----------------------------------|
| Electrical data | Operating voltage | 20-250V AC,20-250V AC/DC |
| | Switching frequency | 25Hz/25Hz AC,40Hz DC |
| | Voltage drop | <9VAC(300mA)/<10VAC, <8VDC |
| | Load current | Max.load:300mA;min.Load:5mA |
| | | Max.load:200mA;min.Load:5mA |
| | Leakge current | ≤2.5mA |
| | Hysteresis | <15%(Sr) |
| | Repeatability | <5.0%(Sr) |
| | Temperature drift | <10%(Sr) |
| | Polarity reversal protection | Yes |
| Environment | Ambient temperature | -25...70°C |
| | Ingress protection | IP67 |
| Mechanical data | Housing material | PBT |
| | Face material | PBT |
| Electrical connection | Connectors | PVC cable/2m;2*0.5mm ² |
| Accessories | Accessories | NO |
| | | (to be ordered separately) |

Wiring





Features:

- Φ34mm Plastic housing;
- 35mm , non-flush mountable;
- AC 2-wire , AC/DC 2-wire , switching output;
- Momentary current:5A(20ms)/2.2A(20ms)
- Cable



Dimensioned drawing

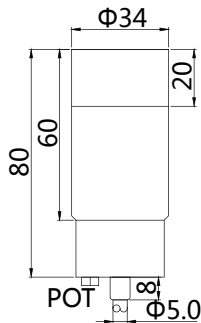

Mounting

(non-flush mounting)

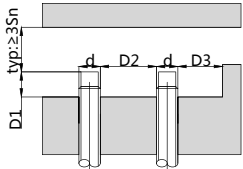

| Correction Factor | |
|-------------------|--------|
| Nav-ferrous metal | Factor |
| Water | 1 |
| Alcohol | 0.7 |
| Ceramic | 0.6 |
| Glass | 0.5 |
| Oil | 0.3 |

Model No.

| Housing material | Sn: 2-35 mm |
|------------------|-----------------|
| N. O | CN-H3435A-P14P2 |
| N. C | CN-H3435A-P24P2 |
| N. O | CN-H3435U-P15P2 |
| N. C | CN-H3435U-P25P2 |

Technical data

| | | |
|------------------------------|------------------------------|--------------------------------|
| Electrical data | Operating voltage | 20-250V AC,20-250V AC/DC |
| | Switching frequency | 25Hz/25Hz AC,40Hz DC |
| | Voltage drop | <9VAC(300mA)/<10VAC,<8VDC |
| | Load current | Max.load:300mA;min.Load:5mA |
| | | Max.load:200mA;min.Load:5mA |
| | Leakge current | ≤2.5mA |
| | Hysteresis | <15%(Sr) |
| | Repeatability | <5.0%(Sr) |
| | Temperature drift | <10%(Sr) |
| | Polarity reversal protection | Yes |
| Environment | Ambient temperature | -25...70°C |
| | Ingress protection | IP67 |
| Mechanical data | Housing material | Brass,nickel-plated/PBT |
| | Face material | PBT |
| Electrical connection | Connectors | PVC 线缆/2m;2*0.5mm ² |
| Accessories | Accessories | NO |
| | (to be ordered separately) | |

Wiring





Features:

- Φ34mm Plastic housing;
- 25mm , flush mountable;
- AC 2-wire , AC/DC 2-wire , switching output;
- Momentary current:5A(20ms)/2.2A(20ms)
- Cable & pigtail versions



Dimensioned drawing

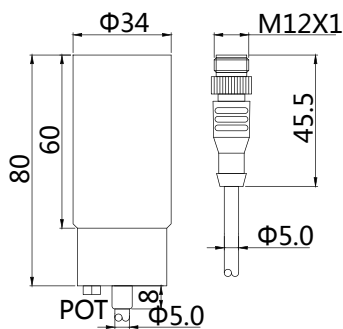

Model No.

| Sensing range | Sn:2-25 mm |
|---------------|------------------|
| N. O | CB-H3425A-P14Z12 |
| N. C | CB-H3425A-P24Z12 |
| N. O | CB-H3425U-P15Z12 |
| N. C | CB-H3425U-P25Z12 |

Mounting

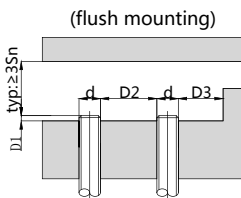

| Correction Factor | |
|-------------------|--------|
| Nav-ferrous metal | Factor |
| Water | 1 |
| Alcohol | 0.7 |
| Ceramic | 0.6 |
| Glass | 0.5 |
| Oil | 0.3 |

Technical data

| | | |
|------------------------------|------------------------------|-----------------------------|
| Electrical data | Operating voltage | 20-250V AC,20-250V AC/DC |
| | Switching frequency | 25Hz/25Hz AC,40Hz DC |
| | Voltage drop | <9VAC(300mA)/<10VAC, <8VDC |
| | Load current | Max.load:300mA;min.Load:5mA |
| | | Max.load:200mA;min.Load:5mA |
| | Leakge current | ≤2.5mA |
| | Hysteresis | <15%(Sr) |
| | Repeatability | <5.0%(Sr) |
| | Temperature drift | <10%(Sr) |
| | Polarity reversal protection | Yes |
| Environment | Ambient temperature | -25...70°C |
| | Ingress protection | IP67 |
| Mechanical data | Housing material | PBT |
| | Face material | PBT |
| Electrical connection | Connectors | M12 connector |
| Accessories | Accessories | B12-4GV2/B12-4WV2 |
| | (to be ordered separately) | |

Wiring





Features :

- Φ34mm Plastic housing;
- 35mm , non-flush mountable;
- AC 2-wire , AC/DC 2-wire , switching output;
- Momentary current:5A(20ms)/2.2A(20ms)
- Cable & pigtail versions



Dimensioned drawing

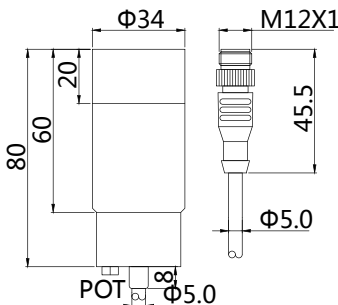

Mounting

(non-flush mounting)

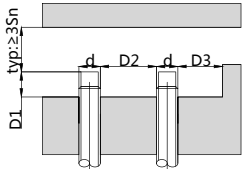

| Correction Factor | |
|-------------------|--------|
| Nav-ferrous metal | Factor |
| Water | 1 |
| Alcohol | 0.7 |
| Ceramic | 0.6 |
| Glass | 0.5 |
| Oil | 0.3 |

Model No.

| Housing material | Sn:2-35 mm |
|------------------|------------------|
| N. O | CN-H3435A-P14Z12 |
| N. C | CN-H3435A-P24Z12 |
| N. O | CN-H3435U-P15Z12 |
| N. C | CN-H3435U-P25Z12 |

Technical data

| | | |
|------------------------------|------------------------------|-----------------------------|
| Electrical data | Operating voltage | 20-250V AC,20-250V AC/DC |
| | Switching frequency | 25Hz/25Hz AC,40Hz DC |
| | Voltage drop | <9VAC(300mA)/<10VAC, <8VDC |
| | Load current | Max.load:300mA;min.Load:5mA |
| | | Max.load:200mA;min.Load:5mA |
| | Leakge current | ≤2.5mA |
| | Hysteresis | <15%(Sr) |
| | Repeatability | <5.0%(Sr) |
| | Temperature drift | <10%(Sr) |
| | Polarity reversal protection | Yes |
| Environment | Ambient temperature | -25...70°C |
| | Ingress protection | IP67 |
| Mechanical data | Housing material | Brass,nickel-plated/PBT |
| | Face material | PBT |
| Electrical connection | Connectors | M12 connector |
| Accessories | Accessories | B12-4GV2/B12-4WV2 |
| | (to be ordered separately) | |

Wiring

